

Varenummer: 4395000381  
 Beskrivelse: Rota-fix spændelement F38x75  
 Rustfast stål

## Mål

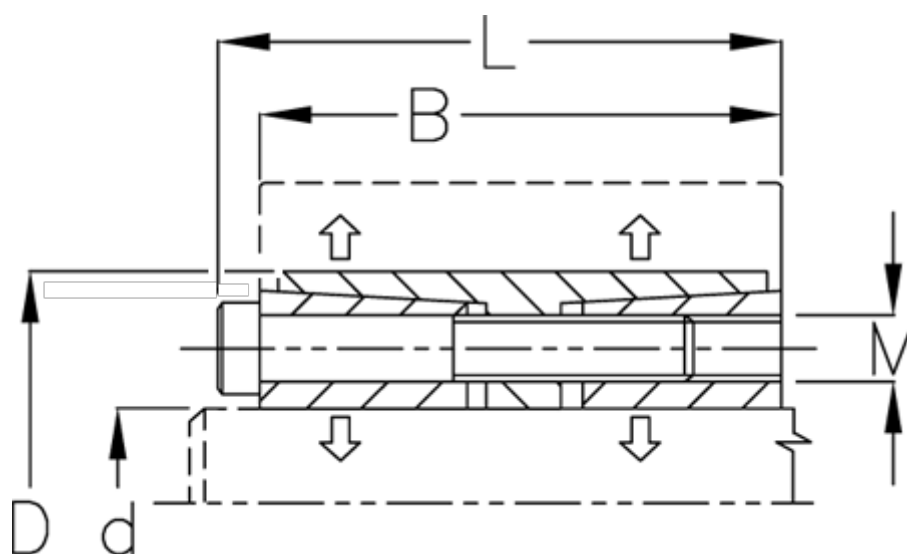

B mm	= 54
d H8 mm	= 38
D mm	= 75
F kN aksialkraft	= 76.7
L mm	= 62
M mm	= M8
Overfladeruhed	= R? ? 3.2 $\mu$ m
P N/mm <sup>2</sup> fladetryk på aksel/nav	= 38

T Nm drejningsmoment	= 1450
Tolerance	= Aksel h8, Nav H8
Ts Nm boltetilspændingsmoment	= 28.7